

C.amara HDCVI

User manual







Foreword

General

This manual explains the functions and uses of the HDCVI camera (hereinafter, "the device").

Security instructions

The following classified signal words with defined meaning may appear in the manual.

signal words	Meaning
 HAZARD	Indicates a highly potential hazard which, if not avoided, will result in death or serious injury.
 CAVEAT	Indicates a hazard of medium or low potential which, if not avoided, could result in minor or moderate injury.
 CAUTION	Indicates a potential risk that, if not avoided, could cause property damage, loss of data, poor performance, or other unpredictable result.
 TIPS	Provides methods to help you solve a problem or save time.
 NOTE	Provide additional information such as emphasis or complement to the text.

revision history

Version	Content of the review	Publication date
V1.0.0	First pitch.	June 2020

About the manual

- The manual is just a reference. If you find any discrepancy between the manual and the actual product, the actual product shall prevail.
- We will not accept any responsibility for losses caused by using the device without following the instructions in the manual.
- The manual will be updated in accordance with the latest laws and regulations of the related jurisdictions. For more information, see the printed manual, the CD-ROM, the QR code or our official website. In the event of a discrepancy between the printed manual and the electronic version, the electronic version.
- All designs and software included herein are subject to change without prior written notice. Product updates may cause discrepancies between the actual product and the manual. Contact customer service requesting the updated program and supplementary documentation.

- Even so, there may be some deviation in the technical data, functions and description of operations, or printing errors. If there is any doubt or dispute, we reserve the right of final explanation.
- Please update the reader software or try other conventional reader software if you cannot open the manual (in PDF format).
- All trademarks, registered trademarks and company names in the manual are the property of their respective owners.
- Please visit our website, contact the provider or customer service if any problems occur while using the device.
- If there are uncertainties or controversies, we reserve the right of final explanation.

Safety Warnings and Precautions

important



electrical safety

- All instructions for use and installation must be carried out in accordance with the electrical safety regulations of your country.
- The power supply must meet the requirements of the SELV standard (Safety Low Voltage) and supply power with the nominal voltage, which meets the limited power supply requirements according to the ICE62368-1 standard. Power supply requirements are indicated on the device label. An easily accessible disconnect device must be incorporated into the building installation wiring.
- Make sure the power adapter meets the device's operating voltage requirements before turning it on (the material and length of the power cord may affect the device's voltage).
- Protect the power cord from being walked on or pinched particularly at plugs, convenience receptacles, and the point where they exit from the device.
- We do not assume any responsibility for fire and electric shock caused by improper handling or installation.

operating requirements

- Do not point the device at strong light, such as lamplight and sunlight. Transport, use and store the device within the permissible limits of humidity and temperature.
- Keep the device away from water or other liquids to prevent damage to internal components.
- Maintain good ventilation to prevent heat buildup.
- Do not subject the unit to high pressure, strong vibration, or splashing water during transportation, storage, and installation.
- When transporting the device, store it in the factory package or use equivalent materials.
- It is recommended to use this device with a lightning rod to improve lightning protection.
- It is recommended to ground the device to improve reliability.
- It is recommended to use a qualified video transmission cable to improve the video quality and use a standard RG59 or higher coaxial cable.



CAVEAT

- Please use components or accessories supplied by the manufacturer, and make sure that professional engineers perform the installation and maintenance of the device.
- The image sensor surface must not be exposed to laser beam radiation in an environment where a laser beam device is used.
- Do not supply two or more power sources for the device; otherwise you may damage the device.
- If PoC power is used, do not connect other device between the device and the PoC transceiver, including UTC, Balun, optical transceiver, distributor, converter, etc.; otherwise the device may burn out.
- The PoC supply voltage is up to 52V. Do not disassemble the device during normal operation; Otherwise, it may endanger both the device and users due to high voltage.

Index of contents

Foreword	II
Important safety warnings and precautions	IV 1
Overview	8
1.1 Introduction	8
1.2 App.....	8
1.3 Transmission distance.....	9
2 Wire connection	10
2.1 Power outlet.....	10
2.2 12 VDC power input port.....	10
2.3 24 VAC power input port	10
2.4 Video output port	eleven
2.5 Audio input port.....	eleven
2.6 Alarm output port	eleven
2.7 DIP switch	12
2.8 HD/SD control cable.....	12
2.9 HDCVI aviation connector	12
3 Configuration and general use	14
3.1 Access the XVR main menu.....	14
3.2 Audio input setting	14
3.3 Operate the PTZ control panel.....	16
3.3.1 OSD operation menu	16
3.3.2 Using autofocus (AF).....	17
4 Camera smart light setup	19
4.1 Turn on/off smart light	19
4.2 Configuring smart light settings	19
5 Configuration of the temperature and humidity chamber	twenty-one
5.1 Activate/Deactivate temperature and humidity.....	twenty-one
5.2 Setting the temperature measurement mode	twenty-one
5.3 Setting the temperature and humidity display.....	twenty-one
5.4 View temperature and humidity.....	22
6 Activate the deterrent camera configuration	2. 3
6.1 Detection range of PIR detector	2. 3
6.2 Set the activation mode.....	2. 3
6.3 Configuring the acoustic alarm and light warning	24
7 Entrance camera setup	25
7.2 Connect node devices in the OSD menu.....	25
7.3 Connect node devices to the XVR.....	25
8 Box camera installation	28
8.1 Lens installation	28
8.1.1 Install type 1 lens	28
8.1.2 Installing the type 2 lens	29
8.2 I/O port installation	30
8.2.1 Cable connection.....	30
8.2.2 Removing the cable	30

8.3	Device installation	31
9	Fisheye camera setup.....	33
9.1	Fisheye dewarping in the live interface	33
9.2	Fisheye dewarping during playback	3. 4
10	Frequently Asked Questions.....	36
10.1	PoC power supply.....	36
10.2	Long-distance feeding	36
10.3	Centralized power supply	37
10.4	Connector water protection	37
11	Maintenance	39

1 Overview

1.1 Introduction

The device complies with the HDCVI standard and supports video transmission and signal control over coaxial cable. The device produces megapixel resolution video signal and needs to be connected to XVR to achieve high speed, long distance and no delay in signal transmission. It can be applied in different scenarios, such as roads, warehouses, underground parking lots, bars, pipelines, and gas stations.

1.2 App

Figure 1-1 Application scenarios

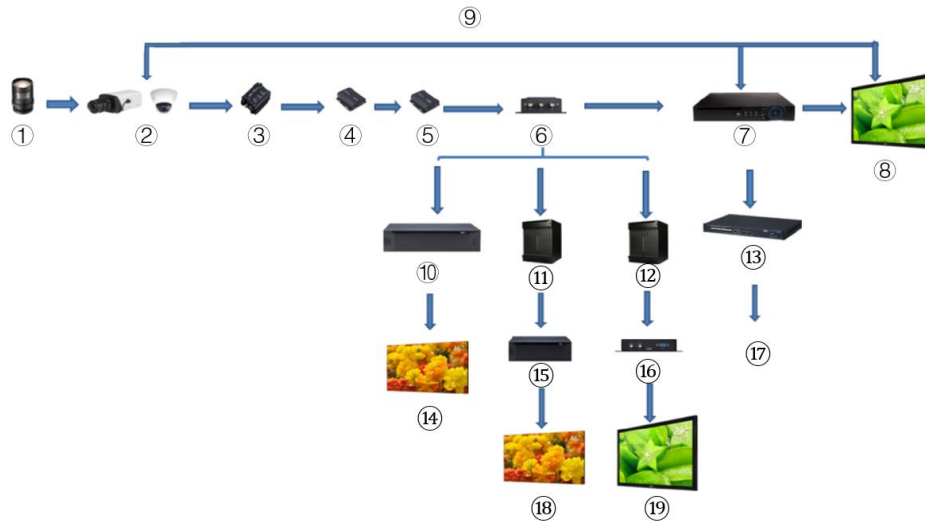

Table 1-1 Application scenarios

No.	Name	No.	Name	No.	Name
1	(Optional) Lens	8	Screen	fifteen	Divider
2	HDCVI Products	9	Direct connection	16	Converter
3	(Optional) Device of protection against surges	10	Platform of integrated video	17	ethernet
4	(Optional) Transceiver optical (send)	eleven	Matrix	18	Screen divided
5	(Optional) Transceiver optical (reception)	12	Matrix	19	Screen
6	(Optional) Dealer	13	switch	—	—
7	HCVR Products	14	split screen	—	—

1.3 transmission distance

Table 1-2 Transmission distance

Wire		720p	1080p	4MP/4K
Coaxial cable	RG6 (75-5)	1200m	800m	700m
	RG59 (75-3)	800m	500m	500m
UTP	CAT6	450m	300m	300m

Table 1-3 Transmission distance of PoC HDCVI enabled by PoC XVR

XVR PoC Series	PoC mode	RG59	RG6
Complete series	AT	100m	100m
	AF	200m	200m

2 Wire connection



Cable types may vary depending on the cameras and the actual product shall prevail.

2.1 power output

Supplies 12 VDC power.



- Check that the power consumption of the devices connected to this port is less than 2W.
- Make sure the power frequency of the devices connected to this port is higher than 1 MHz, such as sound pickup, temperature/humidity sensor and other devices without change of energy consumption. There could be flickers in the image if this port is connected to devices with a power frequency less than 1 MHz, such as fan, room sensor, speaker, motor and others electromechanical devices with change of energy consumption.

Figure 2-1 power output

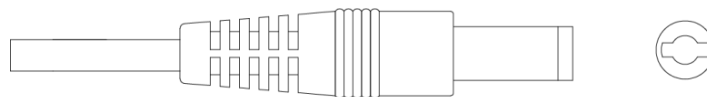

2.2 12 VDC power input port

12V DC inputs.



There could be an abnormality or damage to the device if power is not supplied correctly to the 12 VDC power input port. Check that the supply electrical corresponds to what is indicated in the manual.

Figure 2-2 12 VDC power input port

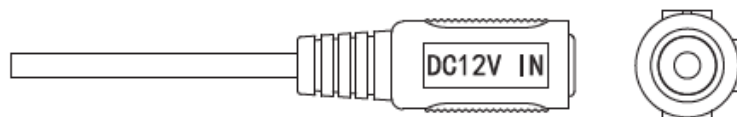

2.3 24 VAC power input port

Supplies 24 VAC power.



Device malfunction or damage may occur if power is not supplied correctly. Be sure to supply power as indicated in the manual.

Figure 2-3 24 VAC power input port



2.4 video out port

Connects the XVR to a video output signal.



CAVEAT

- When the device is in PoC power mode, please do not connect another device between device and PoC XVR or PoC transceiver, including UTC, Balun, optical transceiver, distributor, converter, etc.; otherwise the device could burn.
- PoC power has high voltage. Do not disassemble the device during the normal functioning; otherwise, you could endanger both the device and others users due to high voltage.

Figure 2-4 video out port

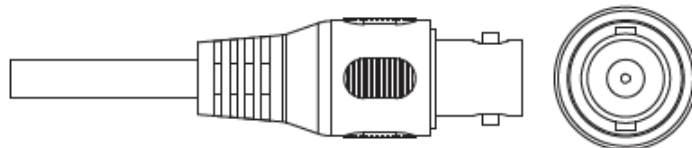

2.5 audio input port

Connects to sound capture devices to receive analog audio signal.

Figure 2-5 audio input port



2.6 alarm output port

Connects to external alarm devices, such as sirens, to trigger an alarm.

Figure 2-6 alarm output port

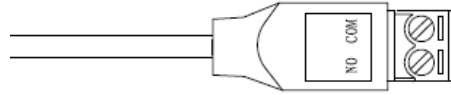

2.7 DIP switch

The DIP Switch changes to change the output mode. Moving up the switch sets "ON", and lowering it indicates "OFF".

Figure 2-7 DIP switch

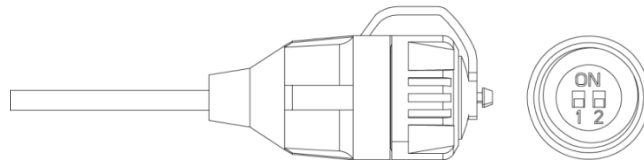

Table 2-1 Using the DIP switch

switch1	switch2	output mode
OFF	OFF	IVC
SWITCHED ON	SWITCHED ON	CVBS
SWITCHED ON	OFF	AHD
OFF	SWITCHED ON	TVI

2.8 HD/SD control cable

When the HD/SD control cable is closed, the video output mode changes from HD to SD. Instead, it will switch back to HD video output when the cable circuit is opened.

Figure 2-8 HD/SD control cable

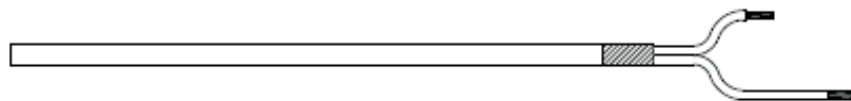

- HD/SD control cable is available on select models.

2.9 HDCVI aviation connector

The aviation connector could strengthen the connection of mobile devices and provide you with four ports for your convenience.

Figure 2-9 HDCVI aviation connector

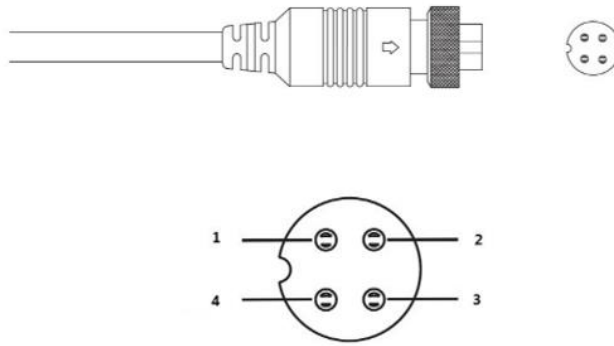

Table 2-2 HDCVI aviation connector components

No.	Name	No.	Name
1	(Yellow): Video	3	(White): Connector video land
2	(Black): Power Neutral	4	(Red): Power

3 Configuration and general use

Power on the device and connect it to the XVR with a coaxial cable. Then the live interface will be displayed. You can then start configuring the HDCVI cameras on the XVR.



- The # of the XVR's coaxial ports will appear in the lower left corner of each window to indicate the corresponding camera.
- Ports may vary depending on XVR models. The actual model shall prevail.

3.1 Access the main menu of the XVR

Step 1 Paso 1: Double click on the live interface, the charms menu will appear direct.

Step 2 Paso 2: Click on **Main menu**(Main Menu) and then access the system. The XVR main menu will appear.

Figure 3-1 XVR main menu

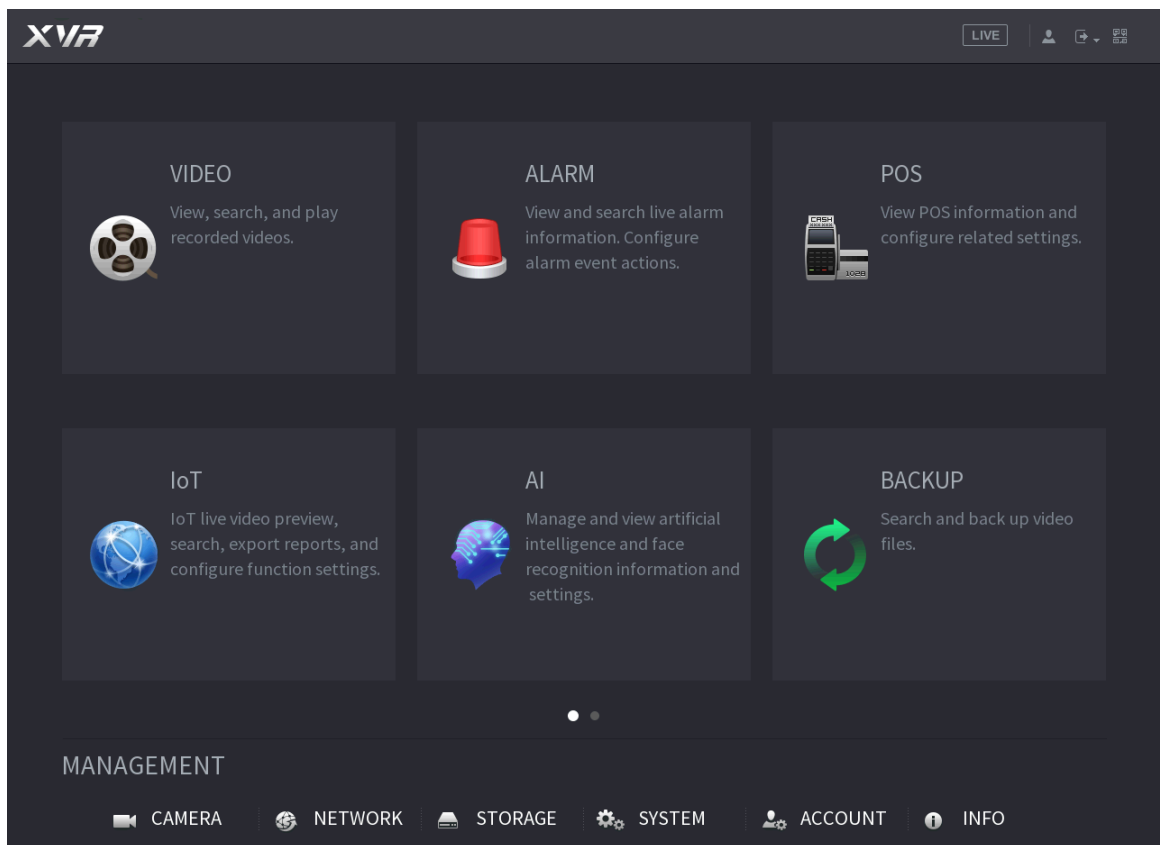

3.2 Audio input setting



Audio input is available on select models.

- Step 3 Paso 1:** In the interface of **Main menu**(Main Menu), select **CAMERA > ENCODE** > **encode**(CAMERA > ENCODE > Encode).
- Step 4 Paso 2:** In the drop down list of **Channel I**(Channel I), select the device that you want to set according to the coaxial port no.
- Step 5 Paso 3:** In **main stream**(Main Stream), click **more settings**(More Setting).

Figure 3-2 encoding settings

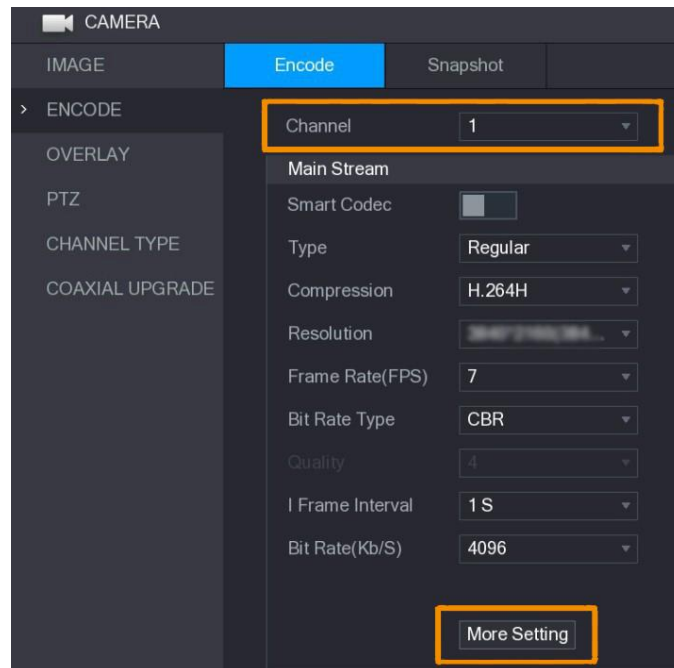

- Step 6 Paso 4:** in the interface **more settings**(More Setting), activate the function **encode audio** (Audio Encode), and then configure the audio settings. On the list **audio format**(Audio Format), leave it at default; on the list **audio source** (Audio Source), select **HDCVI**.

- Step 7 Paso 5:** Click on **Keep**(Save).

Figure 3-3 more settings

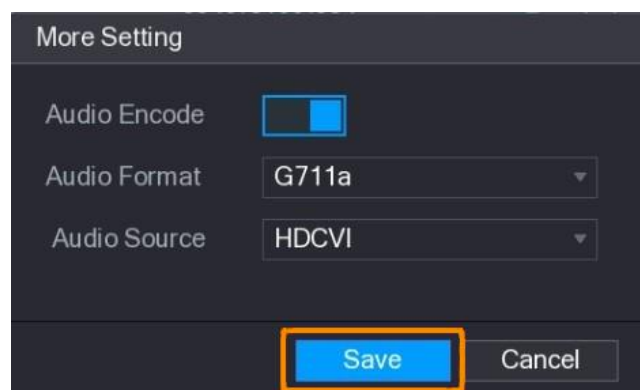

- Step 8 Paso 6:** in the interface **Encode**(Encode), click **Apply**(apply).

3.3 Operate the PTZ control panel

3.3.1 OSD operation menu



- OSD menus of different cameras may vary, and the actual product shall prevail.
- When you use the OSD menu to restore the device to the default settings, The device's resolution, mode, frame rate, and language will not be restored.

Step 9 Paso 1: In the live interface, right click the device you want set up. The quick menu will be displayed.

Figure 3-4 shortcut menu

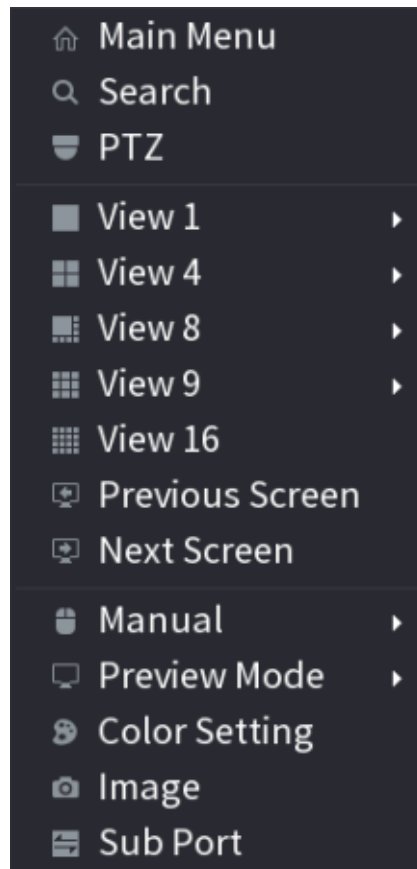

Step 10 Paso 2: Click on **PTZ** and touch  to expand the menu.

Figure 3-5 PTZ Settings Options



Step 11 Paso 3: click on . Dashboard will be displayed **OPERATING MENU** (MENU OPERATION).

Figure 3-6 Menu Usage Panel

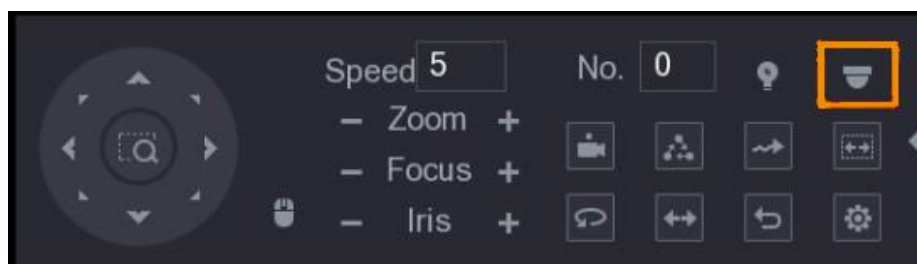
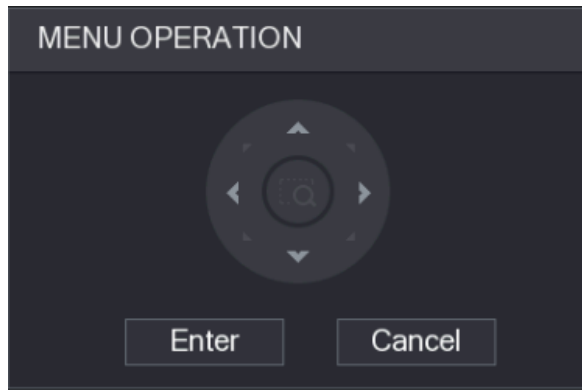
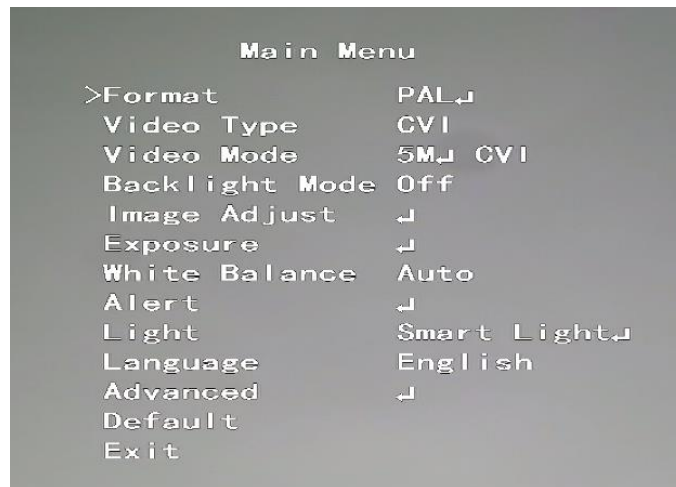

Table 3-1 Menu Usage Panel Function

Button	Function	Button	Function
Enter	Access or confirm an item	Up, Down	Select an item
Cancel	Exit OSD menu	Left, Right	Change element value

The OSD menu of the corresponding device will appear on the live interface. If the value of OSD item is " ", click **Accept**(Enter) to go to the next level of this item. Click on **Return**(Back) to return to the previous level. Click on **Cancel**(Cancel) to exit the OSD menu without saving the changes.







Figure 3-7 On Screen Display (OSD)



3.3.2 Using Auto Focus (AF)

Table 3-2 AF parameter

Parameter	Description
Zoom	<p>–: Reduce.</p> <p>+: Enlarge.</p>
Focus	<p>–: Focus far.</p>

Parameter	Description
	 : Focus close.
Diaphragm	 : Auto focus.  : Open the OSD menu.
PTZ Movement	Compatible with 8 directions.
	Click on  and then you can control the four directions (left, right, up and down) of the PTZ using the mouse.
	Click on  to display the PTZ control panel.

4 Smart light setup

camera

This chapter explains how to set the operating modes of the smart light, including automatic and manual mode. Smart Light will automatically change the white light brightness based on ambient lighting conditions to prevent overexposure. Smart light is only available on full color cameras.

4.1 Turn on/off smart light

Smart light is on by default. Access the OSD menu (Figure 3-7) and select **Light > Smart Light**(Light > Smart Light) to change the smart light mode.

4.2 Configure smart light settings

In smart light mode, set the maximum brightness level of the smart light and the device will automatically change the brightness based on the ambient lighting conditions. You can also set the sensitivity of the smart light.

Brightness level setting

Step 12 Paso 1: In the OSD menu, select **Light > Smart Light > Level** (Light > Smart Light > Level).

Step 13 Paso 2: select from **1a5** to set the maximum brightness level.



The maximum brightness level is 5 by default.

Step 14 Paso 3: Click on **Return**(Return) and then **Go out**(Exit) to leave the setting.



You can also manually set the maximum brightness level in **Light > Manual > Level** (Light > Manual > Level).

Sensitivity setting

Step 15 Paso 1: Select **Light > Smart Light > Sensitivity**(Light > Smart Light > Sensitivity).

Step 16 Paso 2: select from **1a5** to set the light sensitivity value intelligent.



The higher the value, the easier it is to activate the smart light.

The sensitivity level is 3 by default.

Step 17 Paso 3: Click on **Return**(Return) and then **Go out**(Exit) to leave the setting.

5 Configuration of the temperature chamber and humidity

The temperature and humidity camera can measure the ambient temperature and humidity and display the value on the live interface.

5.1 Activate/Deactivate temperature and humidity

Step 18 In the OSD menu (Figure 3-7), select **Advanced > Temp. and humidity** (Advanced > Temp. & Humidity) to activate and deactivate the function. You can see the real-time temperature and humidity in the image.

5.2 Set the temperature measurement mode

The temperature and humidity chamber supports temperature correction in strong light outdoors. You can change the temperature measurement mode.

Step 19 Paso 1: active **Temp. and humidity** (Temp. & Humidity).

Step 20 Paso 2: Select **Standard** (standard) or **Sunlight** (sunlight) in the **measurement mode** (Measure Mode) to change the temperature measurement mode. **Standard** (Standard) is set by default.



It is recommended to change the mode to **Standard** (standard) or **Sunlight** (sunlight) when be used indoors or outdoors, respectively.

5.3 Adjust temperature and humidity display

Step 21 Paso 1: Select **Advanced > Temperature and humidity > Location** (Advanced > Temperature & Humidity > Location) in the OSD menu.



Check that the temperature and humidity function is activated.

Step 22 Paso 2: Click the directional buttons on the PTZ menu to change the location displayed.

Step 23 Paso 3: Click on **Accept** (Enter) to save the settings.

Figure 5-1 Adjust the display of temperature and humidity.

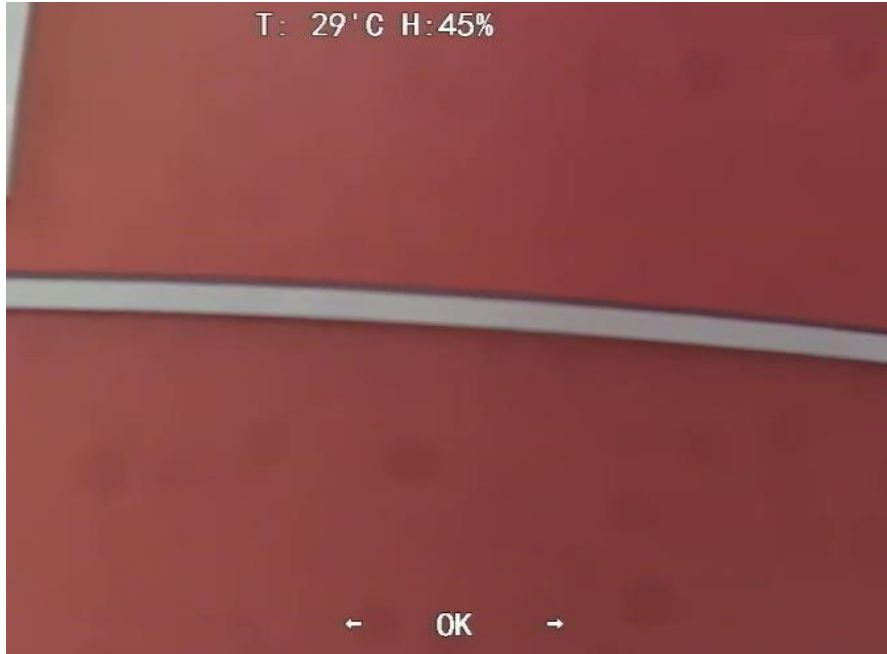

Right click anywhere on the monitoring image to return to the interface above after all settings are completed.

5.4 View temperature and humidity

Step 24 Paso 1: Right click on the live interface to enter the main menu of the XVR (Figure 3-1).

Step 25 Paso 2: Select **IoT > REAL TIME VISUALIZATION**(IoT > REALTIME DISPLAY), and then you can see the temperature and humidity in real time.

Figure 5-2 View temperature and humidity

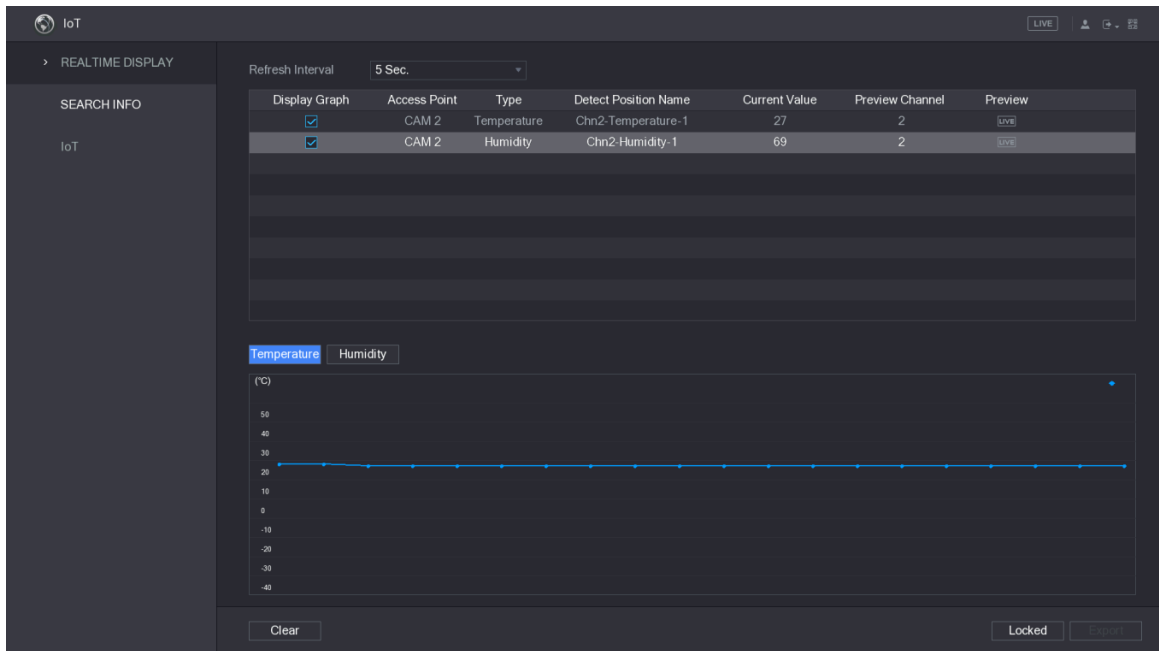

For more information, please refer to the XVR user manual.

6 Activate camera settings deterrent

Activating the deterrence camera can actively warn intruders with LEDs even before users are aware of the breach. Once the intrusion is detected, the LED will turn on to alert the intruder.

6.1 PIR Detector Detection Range

The horizontal detection range of the sensor is 100° or 110°.

Figure 6-1 Horizontal detection range

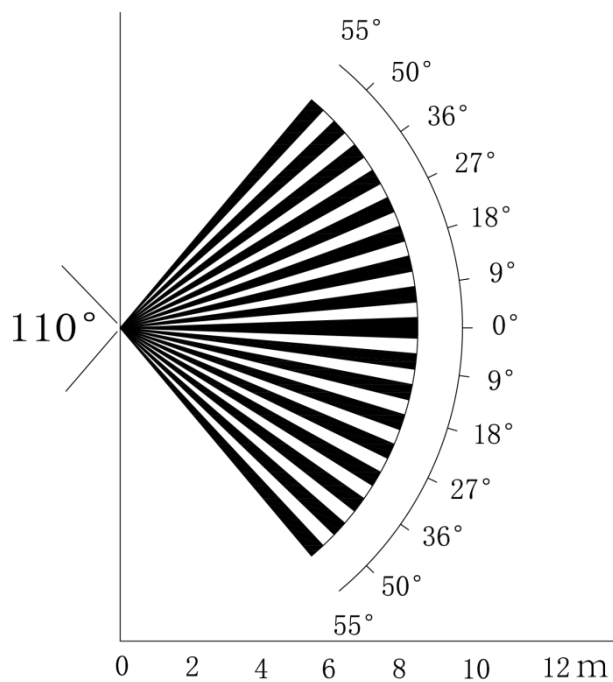

The vertical detection distance of the sensor is 2m-10m, 1m-14m or 1m-12m.

Figure 6-2 Vertical Sensing Distance

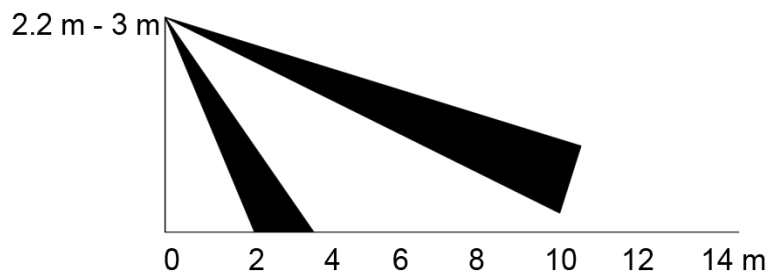

6.2 Set the activation mode

In the OSD menu (Figure 3-7), select **Alerts > Activation mode** (Alert > Trigger Mode).

If you select **Camera**(Camera Set), the acoustic and light alarm will be triggered on the device.

If you select **XVR**(XVR Set), the acoustic and light alarm will be triggered on the XVR.



To see more information about **XVR**(XVR Set), refer to the XVR user manual.

6.3 Set the acoustic alarm and light warning



This function is only available when the activation mode is set to **Camera** (Camera Set).

In the OSD menu (Figure 3-7), select **Alert**(Alert). Adjustment **light warning** (Light Warning) **inactivated**(ON) and then enter the submenu.

- ◇ For **Mode**(Mode), you can choose between **Lightning**(Lighting) and **Flash**.
If you select **Flash**, you can set the **flash frequency**(Flash Frequency) on **Low**(low), **Half**(Medium) or **high**(high).
- ◇ For the **alert duration**(Alert Duration), you can adjust it between 5 seconds and 60 seconds.
The element of **audio alert**(Audio Alert), set it to **Activate**(ON) and then access the item.

- ◇ In **Audio**, you can choose between three different audios.



You can contact the after-sales service to customize the audio of the alarms.

- ◇ The options for the element **Volume**(Volume) are: **Low**(low), **Medium**(Medium) and **High or tall**(high).
- ◇ It is possible to adjust the **alert duration**(Alert Duration) from 5 to 60 seconds.

7 Entrance camera configuration



This feature is available on select models.

This series of devices can serve as the input to connect compatible wireless node devices such as door/window contacts, sirens and PIR detectors to the XVR to form a local alarm network. Once an alarm from a device on the network is triggered, the device transmits an alarm signal according to the settings.

Figure 7-1 Network diagram

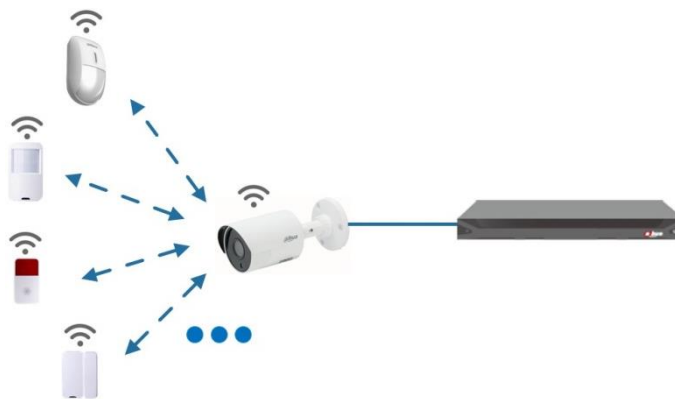

Connect the wireless node devices to the XVR with the gateway camera, and then set the parameters.



For more detailed configuration, please refer to the user manual of the XVR or the node device.

7.2 Connect node devices in OSD menu

Step 26 Paso 1: In the OSD menu (Figure 3-7), select **Advanced**(advanced). configure to

Step 27 Paso 2: **register**(enroll) in **ON** and the device will enter sleep mode.
linkage.

Step 28 Activate the node device and enter pairing mode according to the corresponding manual.

Step 29 Paso 3: After the pairing is finished, it is possible to check the information of the device connected to the interface **Sensor Pairing**(Sensor Paring).

7.3 Connect node devices on the XVR

Step 30 Paso 1: From the XVR main menu (Figure 3-1), select **IoT > ADMINISTRATOR**

> **Sensor Linkage**(IoT > MANAGER > Sensor Pairing).

Step 31 Paso 2: click on **Add**(add).

Figure 7-2 Add sensor linkage (1)

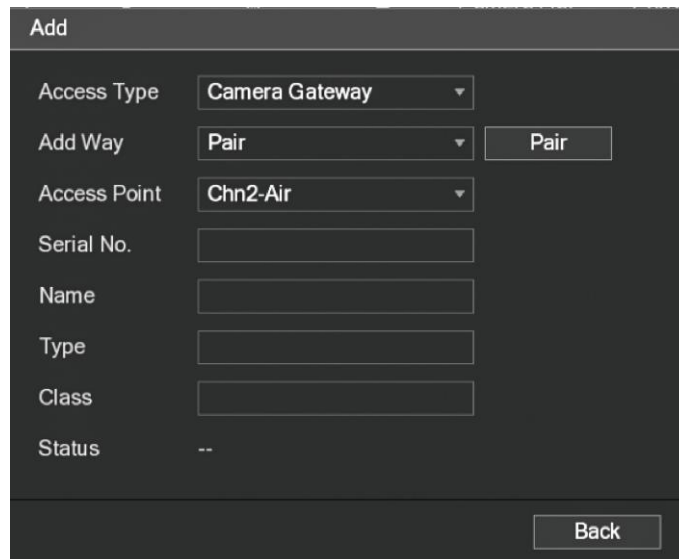

Step 32 Paso 3: On the list **access type** (Access Type), select **door camera link** (Camera Gateway).

Step 33 Paso 4: Click on **Link** (Pair) and the device will enter pairing mode. Use the node device and enter pairing mode.

Figure 7-3 Add sensor linkage (2)

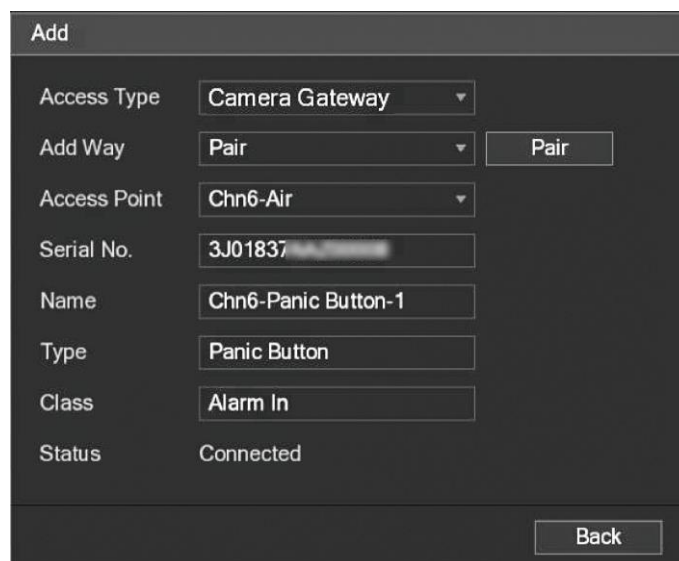

Step 34 Paso 5: Click on **Behind** (Back).





Click on  to modify the device name and click  for remove the node device.

Figure 7-4 connected device



8 Box camera installation

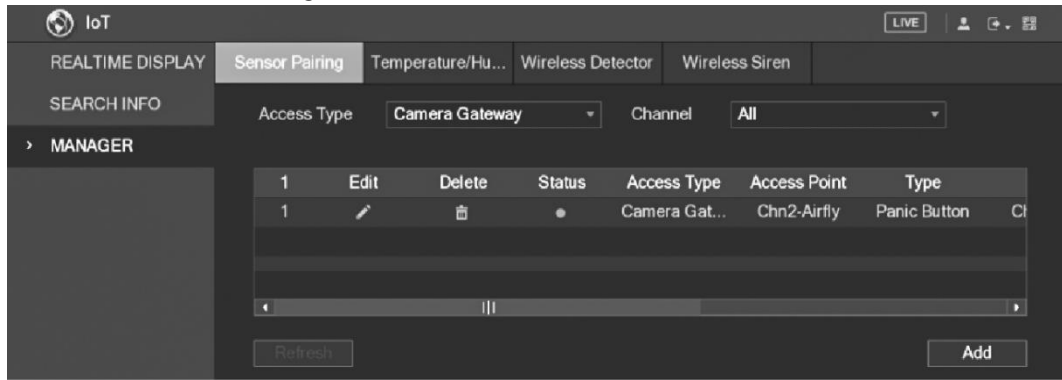

- The lens is not installed on the device when it leaves the factory and is required to install it.
- Do not remove the electrostatic absorption film on the surface of the transparent cover before finishing installation and debugging to avoid damage during installation.
- Install the lens on the device after unpacking it to prevent the lens module from being exposed for a prolonged period to a humid environment.
- The installation surface must be thick enough to support a weight at least 3 times higher than the device.
- Please install the C/CS adapter ring on the camera if you use the C mount lens.
- The following installation figure is for reference only.

8.1 lens installation

8.1.1 Install the type 1 lens

Step 35 Paso 1: Remove the protective cap from the device. Align the lens with the position of device lens (install the C/CS adapter ring on the device if you use the C-mount lens.) Turn it clockwise to secure it well.

Step 36 Paso 2: Insert the lens cable connector into the diaphragm lens socket automatic from the side panel of the device. Skip this step if you are using an auto iris lens.

Step 37 Paso 3: Tighten the screw near the focus ring, then turn it clockwise. counterclockwise to manually pull out the focus ring until you get a clear video image.

Step 38 Paso 4: After the focusing process is complete, tighten the ring close to the ring of focus.

Step 39 Paso 5: Tighten the focus ring.

Figure 8-1 Lens installation (1)

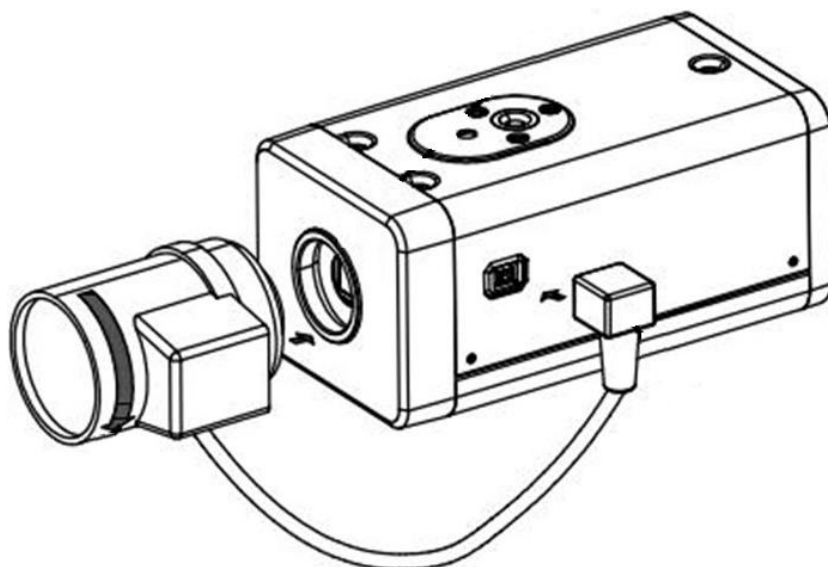

8.1.2 Install the type 2 lens

Figure 8-2 Front panel

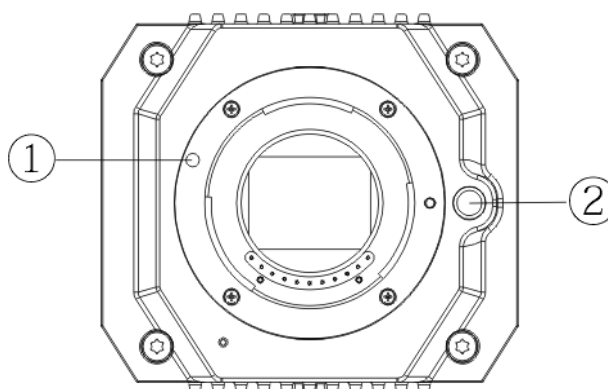

Table 8-1 Front Panel Components

No.	Name	No.	Name
1	red sign	2	lens detach button

Step 40 Paso 1: Remove the protective lens cap from the device, align the red sign on the lens with red sign①device, turn it clockwise until the lens detach button②exit up. The lens installation is complete.

Step 41 Paso 2: Loosen the screw near the focus ring and manually rotate the focus ring. focus outward until you get a clear video image. Skip this step if you are using an autofocus compatible lens.

Figure 8-3 Lens installation (2)

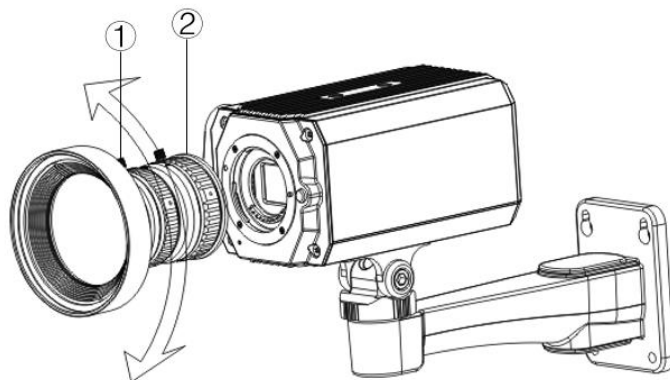

Table 8-2 Lens components

No.	Name	No.	Name
1	Screw	2	focus ring

Step 42 Paso 3: After focusing, tighten the focusing ring screw and fix it.



To detach the lens, press the lens detach button ②, turn the lens clockwise counterclockwise and release the buckle.

8.2 I/O port installation

8.2.1 Cable connection

Step 43 Paso 1: Hold down the mini screwdriver to press the slot button of the cable to be connected.

Step 44 Paso 2: Insert the cable into the slot.

Step 45 Paso 3: Release the screwdriver.

Figure 8-4 install the wire

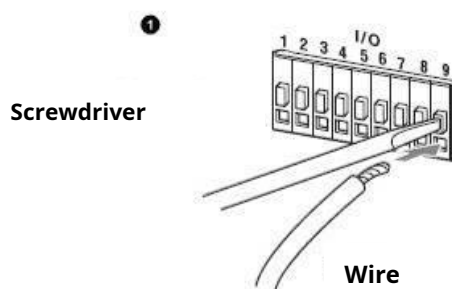

8.2.2 Removing the cable

Step 46 Paso 1: Use the mini screwdriver to press the button of the wire slot to connect.

Step 47 Paso 2: Remove the cable from the slot.

Step 48 Paso 3: Release the screwdriver.

Figure 8-5 remove the wire

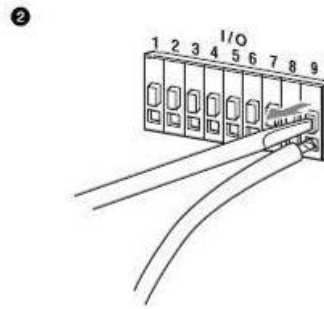

8.3 Device installation



The device is supplied without the bracket and mounting screw. You will have to buy them separately.

Figure 8-6 device components

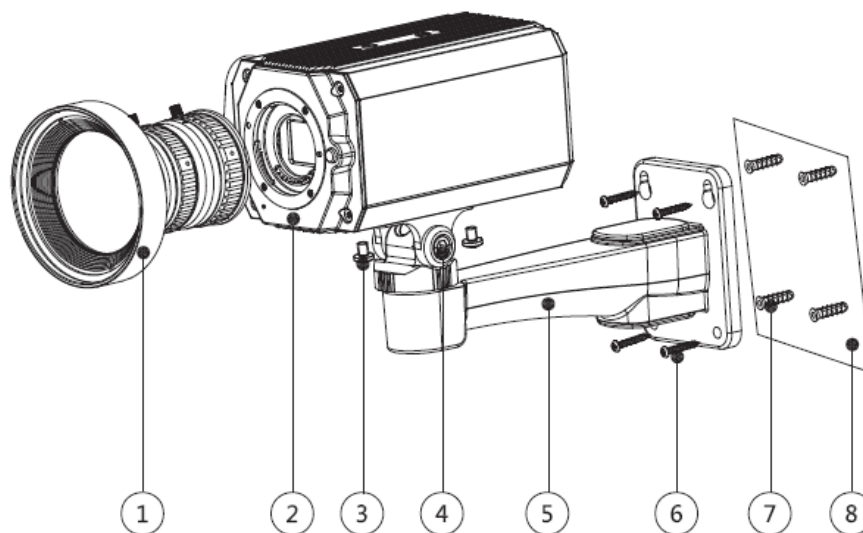

Table 8-3 Device components

No.	Name	No.	Name
1	Lens	5	Mounting bracket
2	Front panel	6	Tapping screw
3	Fixing screw	7	expansion bolt
4	Bracket adjustment screw	8	mounting surface

Step 49 Paso 1: Attach mounting bracket⑤to mounting surface⑧.

- 1) Mark the bracket mounting hole positions on the mounting surface⑧, drill four holes at the marked positions, insert four expansion bolts⑦into the mounting holes and tighten them.
- 2) Align the four screw holes on the bottom of the mounting bracket⑤ using the expansion bolts, insert four self-tapping screws⑥and then tighten them.

Step 50 Paso 2: Secure the device on the mounting bracket⑤.

Step 51 Align the mounting hole positions on the bottom of the device case with the mounting hole positions on the mounting bracket ②, and then install the device on the mounting bracket with the fixing screw ②.

Step 52 Paso 3: Adjust the monitoring angle of the camera.

Step 53 Use a wrench to loosen the adjustment screw ②, adjust the camera to the place to be monitored, and then use the wrench to tighten the bracket adjustment screw ② to fix the device.

Step 54 Paso 4: Connect the cable to the rear panel of the device.

Step 55 After installing the device and connecting the cable, you can view the monitoring image through a storage device such as the XVR.

9 Fisheye Camera Setup

The fisheye camera (panoramic camera) has a wide monitoring angle, but the video is distorted. The spherical correction function can provide a video image suitable and vivid for human eyes. The fisheye function should be configured on the XVR.

9.1 Fisheye dewarping in the live interface

Step 56 Paso 1: In the XVR shortcut menu, select **Fish eye**(Fisheye). Set the **adjusted mode**(
Step 57 Paso 2: Fit Mode) and the **sample mode**(show mode)
of eye
of fish.

Figure 9-1 fisheye menu

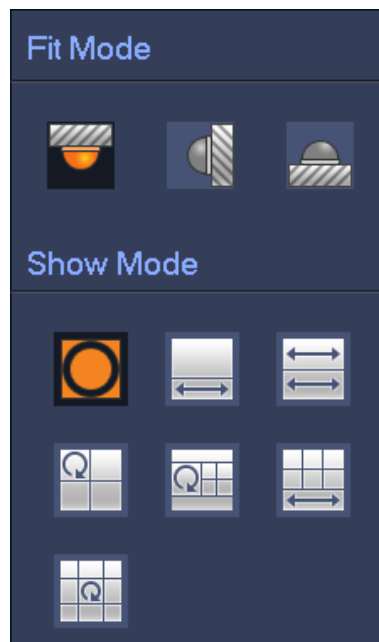

Table 9-1 Fisheye Parameters

adjusted mode	Icon	Description
		Original 360° panoramic window
ceiling mount (1 spherical correction window and 1 panoramic enlarged window
floor mount (2 panoramic enlarged windows
		1 360° panoramic window and 3 spherical correction windows
		1 360° panoramic window and 4 spherical correction windows

adjusted mode	Icon	Description
		4 spherical correction windows and 1 panoramic enlarged window
		1 360° panoramic window and 8 spherical correction windows
wall mount 		Original 360° panoramic window
		Panoramic enlarged window
		1 panoramic display window and 3 spherical correction windows
		1 panoramic display window and 4 spherical correction windows
		1 panoramic display window and 8 spherical correction windows



- Spherical correction modes may vary according to different modes of installation.
- For the non-fisheye channel, a prompt will be displayed reminding you that the spherical correction is not supported.
- Some series of products are compatible with 180° spherical correction that can only be wall mounted. The actual product shall prevail.

Figure 9-2 Fisheye display mode



You can use the mouse to drag the colored areas of the left original screen or the rectangular screens on the right to change monitoring ranges. (not compatible with wall mounting).

9.2 Fisheye dewarping during playback

When you play the video recorded with fisheye, you can use the correction function ball to fit the video.

Step 1: On the XVR main menu, click **SEEK**(SEARCH).

Step 2: Select 1-window playback mode and fisheye channel
and then click to play it. 

Step 3: Right click to go to playback interface with
spherical correction.

10 Frequently Asked Questions

10.1 PoC power supply

PoC XVR supports PoC function.

PoC camera can be divided into AT camera and AF camera. The power consumption of the AT camera is less than 12 W and the power consumption of the AF camera is less than 6 W.

You must check the maximum power of PoC before using it. Assuming the maximum power of an XVR is 48 W, the XVR can connect AT cameras up to $48/12=4$ or AF cameras up to $48/6=8$.

When the device is in PoC power mode, please do not connect other device between the device and PoC XVR or PoC Transceiver, such as UTC, Balun, Optical Transceiver, Distributor, Converter, etc.; otherwise the device may burn out.

PoC power has high voltage. Do not disassemble the device during normal operation; Otherwise, it may endanger both the device and users due to high voltage.

10.2 long distance feeding

In many cases, our customers use long-distance power, transmitting 12VDC to cameras that are more than 100m away. This type of feeding could cause problems.

Q1: Devices reboot repeatedly or there is an ICR failure.

Possible reasons: A long power cable can lead to large voltage drops of the equipment's power cable, and turning on the IR light at night increases this voltage drop, resulting in the device rebooting. After the device is rebooted, the ICR defaults to Day mode. Based on the night ambient light, the device will work in Night mode, and then the infrared light will light up, causing the device to reboot due to low voltage. In this way, the ICR is activated every 2 seconds, affecting its useful life.

Q2: Can't reboot the device at night, get black screen or reboot when activating ICR.

Possible reasons: A long power cord can lead to large voltage drops of the equipment's power cord, and turning on the IR light at night increases the voltage drop, resulting in device reboot and black screen.

Solution: During construction, if the camera location is far from the power supply, you need to use a separate long-distance power supply or purchase a double DP power supply to use 24VAC power.

10.3 centralized power supply

The usual problem with a centralized power supply is that obvious black stripes appear on the device screen, interfering with display.

The principle of centralized power is as follows:

Figure 10-1 Centralized feeding principle

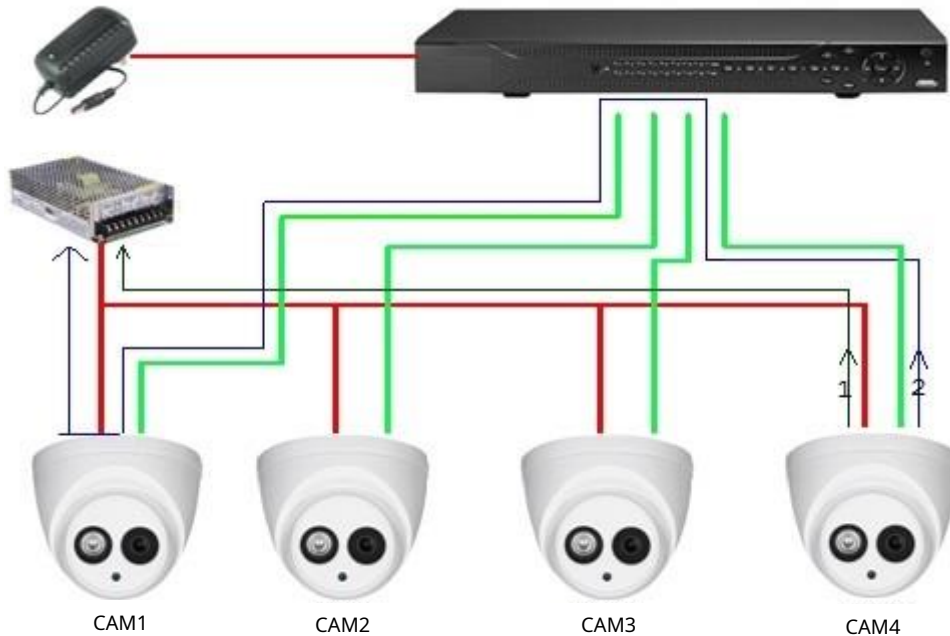

The power output of CAM4 has two paths, return path 1 and return path 2. Return path 2 first flows to CAM1 and then flows to the power supply from the power supply ground of CAM1. In this way, the backflow of the power supply ground of CAM4 affects the video ground of CAM1, resulting in interference streaks on the screen. CAM4 also interferes with CAM2 and CAM3.

Similarly, CAM1, CAM2, or CAM3 affects the other cameras as well as itself.

The main reason for centralized power interference is that the ground connection of the camera's power supply is not isolated. To resolve this issue: Use dual power devices with isolation from the power source ground; equip low power devices with electrical isolators to block the return path 2. Use isolated power supplies for each channel or power the device separately. These are the two recommended methods.

10.4 Connector water protection

HDCVI cameras need to be waterproof and well protected. Once installed, wrap the BNC connector and power connector tightly with insulating or waterproof tape to prevent the ingress of water and external electromotive forces. When a device with a metal casing is installed on metal surfaces, such as elevators or buses, the metal casing should not be in contact with the installation surface to prevent the ingress of water and external electromotive forces.

Figure 10-2 Water protection measures

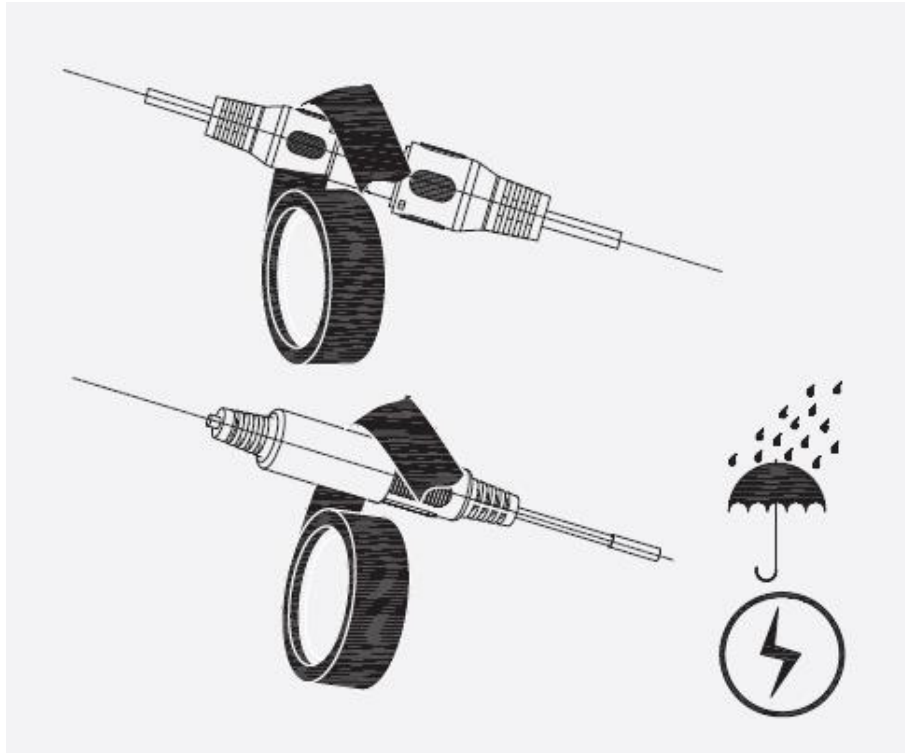

11 Maintenance



To maintain image quality and correct device operation,
Please read the following maintenance instructions carefully and keep a
strong adhesion.

Disassembly and replacement of the desiccant

- Carefully follow the instructions in the manual when performing any device disassembly operations; Otherwise, it may cause water leakage or poor image quality due to unprofessional disassembly.
- Please contact after-sales service for desiccant replacement if condensation appears on the lens after taking it out of the box or when the desiccant turns green. (Not all models include desiccant.)

Lens and lens protector maintenance

- The lens and lens protector are covered with an anti-reflective coating that may become contaminated or damaged, resulting in lens scratches or blurred images, if they come in contact with dust, grease, fingerprints, or other similar substances.
- Do not directly touch the image sensor (CCD or CMOS). Dust and dirt can be removed with an air blower, or you can wipe the lens gently with a soft cloth moistened with alcohol.

Device Body Maintenance

- The device casing can be cleaned with a dry cloth, which can be slightly moistened with mild detergent to remove stubborn stains.
- To avoid possible damage to the coating of the device casing which could cause a decrease in performance, do not use volatile solvents such as alcohol, benzene, white spirit, etc. to clean the device casing, nor can you use a strong abrasive detergent .