

Installation Guide

Omada VPN Gateway

About this Installation Guide

This Installation Guide describes the hardware characteristics, installation methods and the points that should be attended to during the installation. This Installation Guide is structured as follows:

Chapter 1 Introduction

This chapter describes the external components of the gateway.

Chapter 2 Installation

This chapter illustrates how to install the gateway.

Chapter 3 Hardware Connection

This chapter illustrates how to do the physical connection of the gateway.

Chapter 4 Software Configuration

This chapter illustrates how to configure the gateway.

Appendix A Troubleshooting

Appendix B Specifications

Audience



This Installation Guide is for:

Network Engineer

Network Administrator

Conventions

- Some models featured in this guide may be unavailable in your country or region. For local sales information, visit <https://www.tp-link.com>.
- The figures in Chapter 2, Chapter 3, and Chapter 4 are for demonstration purposes only. Your device may differ in appearance from that depicted.
- This guide uses the specific formats to highlight special messages. The following table lists the notice icons that are used throughout this guide.

	Remind to be careful. A caution indicates a potential which may result in device damage.
	Remind to take notice. The note contains the helpful information for a better use of the product.

Related Document

The User Guide of the product are provided on Download Center. To obtain the latest product information, visit the official website: <https://www.tp-link.com>.

Contents

Chapter 1	Appearance	01
1.1	Front Panel	01
1.2	Rear Panel	07
Chapter 2	Installation	09
2.1	Package Contents	09
2.2	Safety Precautions	09
2.3	Installation Tools	11
2.4	Product Installation	12
Chapter 3	Hardware Connection	14
Chapter 4	Software Configuration	15
4.1	For Common Gateways	15
4.2	For Gateways with Controller Ability	18
Appendix A	Troubleshooting	20
Appendix B	Specifications	20

Chapter 1 Appearance

1.1 Front Panel

The figures are for demonstration only. They may differ from your actual products.

- The front panel of ER7412-M2 is shown as the following figure.

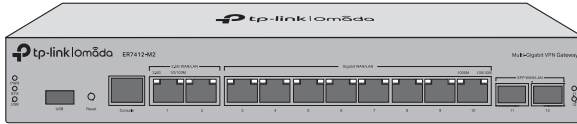

LED	Indication
PWR	<p>On: The gateway is powered on.</p> <p>Off: The gateway is powered off or power supply is abnormal.</p>
SYS	<p>Slow Flashing: System is running normally.</p> <p>Quick Flashing: The gateway is being reset.</p> <p>On or Off: System is starting up or running abnormally.</p>
USB	<p>For USB Modem:</p> <p>Flashing: A modem is connected, and it is initializing.</p> <p>On: The modem is loaded.</p> <p>Off: No modem is inserted, or it is corrupted or incompatible.</p> <p>For USB Storage:</p> <p>On: A USB storage device is inserted and identified.</p> <p>Off: No USB storage device is inserted, or it is corrupted or incompatible.</p>
<p>Link/Act</p>	<p>For 2.5G Port:</p> <p>Green On: Running at 2.5 Gbps, but no activity.</p> <p>Green Off: No device is linked to the corresponding port.</p> <p>Green Flashing: Running at 2.5 Gbps, and transmitting or receiving data.</p> <p>Yellow On: Running at 1000/100/10 Mbps, but no activity.</p> <p>Yellow Off: No device is linked to the corresponding port.</p> <p>Yellow Flashing: Running at 1000/100/10 Mbps, and transmitting or receiving data.</p> <p>For Gigabit Port:</p> <p>Green On: Running at 1000 Mbps, but no activity.</p> <p>Green Off: No device is linked to the corresponding port.</p> <p>Green Flashing: Running at 1000 Mbps, and transmitting or receiving data.</p> <p>Yellow On: Running at 100/10 Mbps, but no activity.</p> <p>Yellow Off: No device is linked to the corresponding port.</p> <p>Yellow Flashing: Running at 100/10 Mbps, and transmitting or receiving data.</p>

LED	Indication
11-12	<p>On: The corresponding SFP port is running at 1000 Mbps, but no activity.</p> <p>Off: No device is linked to the corresponding port.</p> <p>Flashing: The corresponding SFP port is running at 1000 Mbps, and transmitting or receiving data.</p>

Interface	Description
USB	USB 3.0 port for USB modem and USB storage device.
Reset	Press and hold the button for 5 seconds, the SYS LED will flash quickly, indicating the device is being reset to its factory default settings.
Console	Connect with a computer for monitoring and configuring the gateway.
Port 1	2.5G RJ45 WAN/LAN port. By default, it is a WAN port. You can configure it to a LAN port on the management page
Port 2	2.5G RJ45 WAN/LAN port. By default, it is a LAN port connecting to local PCs or switches. You can configure it to a WAN port on the management page.
Port 3	Gigabit RJ45 WAN/LAN port. By default, it is a WAN port. You can configure it to a LAN port on the management page.
Port 4-10	Gigabit RJ45 WAN/LAN ports. By default, they are LAN ports connecting to local PCs or switches. You can configure each port to a WAN port on the management page.
Port 11-12	Gigabit SFP WAN/LAN port connecting to an SFP module. By default, it is a LAN port. You can configure it to a WAN port on the management page.

- The front panel of ER7406 is shown as the following figure.



LED	Indication
PWR	<p>On: The gateway is powered on.</p> <p>Off: The gateway is powered off or power supply is abnormal.</p>
SYS	<p>Slow Flashing: System is running normally.</p> <p>Quick Flashing: The gateway is being reset.</p> <p>On or Off: System is starting up or running abnormally.</p>

LED	Indication
SFP	<p>On: The SFP port is running at 1000 Mbps, but no activity.</p> <p>Off: No device is linked to the SFP port.</p> <p>Flashing: The SFP port is running at 1000 Mbps, and transmitting or receiving data.</p>
USB	<p>For USB Modem:</p> <p>Flashing: A modem is connected, and it is initializing.</p> <p>On: The modem is loaded.</p> <p>Off: No modem is inserted, or it is corrupted or incompatible.</p> <p>For USB Storage:</p> <p>On: A USB storage device is inserted and identified.</p> <p>Off: No USB storage device is inserted, or it is corrupted or incompatible.</p>
Link/Act	<p>Green On: Running at 1000 Mbps, but no activity.</p> <p>Green Off: No device is linked to the corresponding port.</p> <p>Green Flashing: Running at 1000 Mbps, and transmitting or receiving data.</p> <p>Yellow On: Running at 100/10 Mbps, but no activity.</p> <p>Yellow Off: No device is linked to the corresponding port.</p> <p>Yellow Flashing: Running at 100/10 Mbps, and transmitting or receiving data.</p>

Interface	Description
USB	USB 3.0 port for USB modem and USB storage device.
Reset	Press and hold the button for 5 seconds, the SYS LED will flash quickly, indicating the device is being reset to its factory default settings.
Port 1	SFP WAN/LAN port. By default, it is a WAN port. You can configure it to a LAN port on the management page
Port 2	Gigabit RJ45 WAN port.
Port 3-6	Gigabit RJ45 WAN/LAN ports. By default, they are LAN ports connecting to local PCs or switches. You can configure each port to a WAN port on the management page.

The front panel of ER8411 is shown as the following figure.

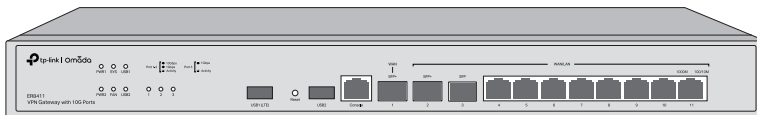

LED	Indication
PWR1*	<p>On: The gateway is powered by PWR1.</p> <p>Off: PWR1 is disconnected or it works improperly, or the gateway is powered off.</p>
PWR2	<p>Green On: The gateway is powered by PWR2.</p> <p>Yellow On**: PWR2 are connected, but the gateway is powered by PWR1.*</p> <p>Off: PWR2 is disconnected or it works improperly, or the gateway is powered off.</p>

LED	Indication
SYS	<p>Flashing: The gateway works properly.</p> <p>On or Off: The gateway works improperly.</p> <p>Quick Flashing: The gateway is being reset.</p>
FAN	<p>Green On: The fan works properly.</p> <p>Yellow On: The fan works improperly.</p>
USB	<p>For USB Modem:</p> <p>Flashing: A modem is connected and it is initializing.</p> <p>On: The modem is loaded.</p> <p>Off: No modem is inserted, or it is corrupted or incompatible.</p> <p>For USB Storage:</p> <p>On: A USB storage device is inserted and identified.</p> <p>Off: No USB storage device is inserted, or it is corrupted or incompatible.</p>
SFP+ (Port 1-2)	<p>Green On: Running at 10 Gbps, but no activity.</p> <p>Green Flashing: Running at 10 Gbps and transmitting or receiving data.</p> <p>Yellow On: Running at 1000 Mbps, but no activity.</p> <p>Yellow Flashing: Running at 1000 Mbps and transmitting or receiving data.</p> <p>Off: No device is linked to the corresponding port.</p>
SFP (Port 3)	<p>On: Running at 1000 Mbps, but no activity.</p> <p>Flashing: Running at 1000 Mbps and transmitting or receiving data.</p> <p>Off: No device is linked to the corresponding port.</p>
RJ45 (Port 4-11)	<p>Green On: Running at 1000 Mbps, but no activity.</p> <p>Green Flashing: Running at 1000 Mbps and transmitting or receiving data.</p> <p>Yellow On: Running at 100/10 Mbps, but no activity.</p> <p>Yellow Flashing: Running at 100/10 Mbps and transmitting or receiving data.</p> <p>Off: No device is linked to the corresponding port.</p>
<p>*PWR1 is the primary power supply and it takes priority over PWR2.</p> <p>**When both PWR1 and PWR2 work properly and the gateway is powered by PWR1, it takes 10-20 seconds for the LED PWR2 (yellow) to go out.</p>	

Interface	Description
USB1 (LTE)	USB 3.0 port for USB modem and USB storage device.
Reset	Press and hold the button for 5 seconds, the SYS LED will flash quickly, indicating the device is being reset to its factory default settings.
USB2	USB 3.0 port for USB storage device.
Console	Connect with a computer for monitoring and configuring the gateway.
SFP+ WAN (Port 1)	10G SFP+ WAN port.

SFP+ WAN/LAN (Port 2)	10G SFP+ WAN/LAN port connecting to an SFP+ module. By default, it is a LAN port. You can configure it to a WAN port on the management page.
SFP WAN/LAN (Port 3)	Gigabit SFP WAN/LAN port connecting to an SFP module. By default, it is a LAN port. You can configure it to a WAN port on the management page.
Port 4	Gigabit RJ45 WAN/LAN port. By default, it is a WAN port. You can configure it to a LAN port on the management page
Port 5-11	Gigabit RJ45 WAN/LAN ports. By default, they are LAN ports connecting to local PCs or switches. You can configure each port to a WAN port on the management page.

- The front panel of ER8411C-M2 is shown as the following figure.

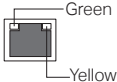

LED	Indication
PWR	On: The gateway is powered on. Off: The gateway is powered off or power supply is abnormal.
SYS	Slow Flashing: System is running normally. Quick Flashing: The gateway is being reset. On or Off: System is starting up or running abnormally.
USB	For USB Modem: Flashing: A modem is connected and it is initializing. On: The modem is loaded. Off: No modem is inserted, or it is corrupted or incompatible. For USB Storage: On: A USB storage device is inserted and identified. Off: No USB storage device is inserted, or it is corrupted or incompatible.
CLOUD	On: The device is bound to a TP-Link ID. Slow Flashing: The device is connected to cloud but not bound to a TP-Link ID. Quick Flashing: The device is being reset to its factory default settings. Off: The device is disconnected from cloud.

LED	Indication
1 - 2 (Port 1&Port 2)	<p>Green On: Running at 10 Gbps, but no activity.</p> <p>Green Flashing: Running at 10 Gbps and transmitting or receiving data.</p> <p>Yellow On: Running at 1 Gbps, but no activity.</p> <p>Yellow Flashing: Running at 1 Gbps and transmitting or receiving data.</p> <p>Off: No device is linked to the corresponding port.</p>
<p>Link/Act</p> 	<p>For 2.5G Port (Port 3):</p> <p>Green On: Running at 2.5 Gbps, but no activity.</p> <p>Green Off: No device is linked to the corresponding port.</p> <p>Green Flashing: Running at 2.5 Gbps, and transmitting or receiving data.</p> <p>Yellow On: Running at 1000/100/10 Mbps, but no activity.</p> <p>Yellow Off: No device is linked to the corresponding port.</p> <p>Yellow Flashing: Running at 1000/100/10 Mbps, and transmitting or receiving data.</p> <p>For Gigabit Port (Port 4-11):</p> <p>Green On: Running at 1000 Mbps, but no activity.</p> <p>Green Off: No device is linked to the corresponding port.</p> <p>Green Flashing: Running at 1000 Mbps, and transmitting or receiving data.</p> <p>Yellow On: Running at 100/10 Mbps, but no activity.</p> <p>Yellow Off: No device is linked to the corresponding port.</p> <p>Yellow Flashing: Running at 100/10 Mbps, and transmitting or receiving data.</p>

Interface	Description
USB	USB 3.0 port for USB modem and USB storage device.
Reset	Press and hold the button for 5 seconds, the SYS LED will flash quickly, indicating the device is being reset to its factory default settings.
SFP+ WAN (Port 1)	10G SFP+ WAN port.
SFP+ WAN/LAN (Port 2)	10G SFP+ WAN/LAN port connecting to an SFP+ module. By default, it is a LAN port. You can configure it to a WAN port on the management page.
2.5G WAN/LAN (Port 3)	2.5G RJ45 WAN/LAN port. By default, it is a WAN port. You can configure it to a LAN port on the management page.
Port 4	Gigabit RJ45 WAN/LAN port. By default, it is a WAN port. You can configure it to a LAN port on the management page
Port 5-11	Gigabit RJ45 WAN/LAN ports. By default, they are LAN ports connecting to local PCs or switches. You can configure each port to a WAN port on the management page.

1.2 Rear Panel

The figures are for demonstration only. They may differ from your actual products.

- The rear panel of ER7412-M2 is shown as the following figure.

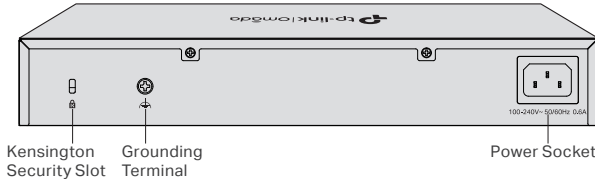

- The rear panel of ER7406 is shown as the following figure.

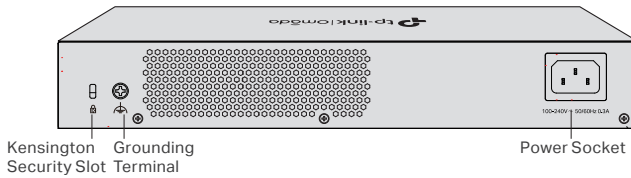

- The rear panel of ER8411 is shown as the following figure.

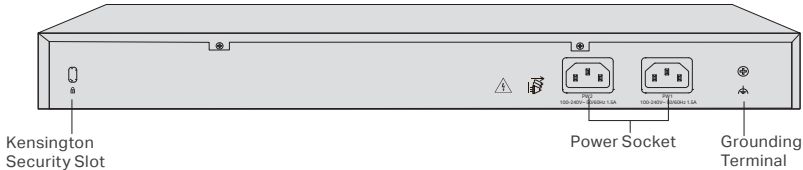

Note:
PWR1 is the primary power supply and it takes priority over PWR2.

- The rear panel of ER8411C-M2 is shown as the following figure.

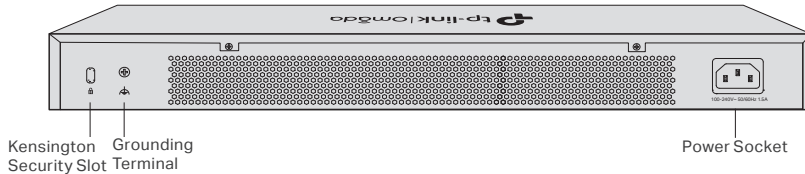

Kensington Security Slot

Secure the lock (not provided) into the security slot to prevent the device from being stolen.

Grounding Terminal

The device already comes with lightning protection mechanism. You can also ground the device through the PE (Protecting Earth) cable of AC cord or with Ground Cable. For detailed lightning protection measures, refer to the **Lightning Protection Guide** from the Related Documents:
https://www.tp-link.com/us/configuration-guides/lightning_protection_guide/.

Power Socket

Connect the female connector of the power cord here, and the male connector to the AC power outlet. Make sure that the voltage of the power supply meets the requirement of the input voltage (100–240 V~ 50/60 Hz).

**Caution:**

Please use the provided power cord.

Chapter 2 Installation

2.1 Package Contents

Make sure that the package contains the following items. Please contact your distributor, if any of the listed items is damaged or missing. The figures are for demonstration only. The actual items may differ in appearance and quantity from the depicted.

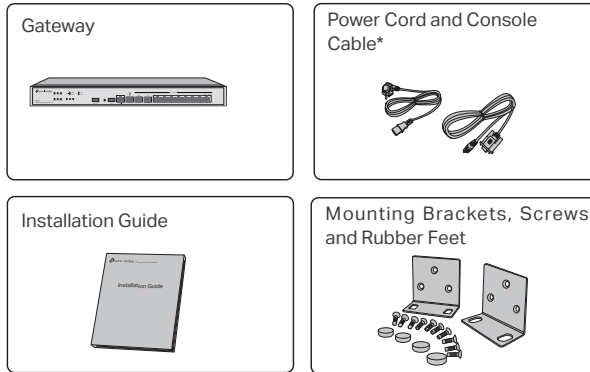
**Note:**

*ER7406 and ER8411C-M2 do not come with a console port and the console cable is not provided.

2.2 Safety Precautions

To avoid any device damage and bodily injury caused by improper use, you should observe the following rules.

■ Safety Precautions

- Keep the power off during the installation.
- Wear an ESD-preventive wrist strap, and make sure that the wrist strap has a good skin contact and is well grounded.
- Use only the power cord provided with the device.
- Make sure that the supply voltage matches the specifications indicated on the rear panel of the device.
- Ensure that the device is installed in a well-ventilated environment and its ventilation hole is not blocked.
- Do not open or remove the cover of the device.
- Before cleaning the device, cut off the power supply. Do not clean it by the waterish cloth, and never use any other liquid cleaning method.
- Place the device with its bottom surface downward.

■ Site Requirements

Temperature/Humidity



Keep the equipment room at an appropriate level of temperature and humidity. Too much or too little humidity may lead to bad insulation, leakage of electricity, mechanical property changes, and corrosion. High temperatures may accelerate aging of the insulation materials, significantly shortening the service life of the device. To find out the best temperature and humidity conditions for the device, check the device's datasheet.

Cleanness



The dust accumulated on the device can be absorbed by static electricity and result in poor contact of metal contact points. Some measures have been taken for the device to prevent static electricity, but too strong static electricity can cause deadly damage to the electronic elements on the internal circuit board. To avoid the effect of static electricity on the operation of the device, attach much importance to the following items:

- Dust the device regularly, and keep the indoor air clean.
- Keep the device well grounded and ensure that the static electricity has been transferred.

Electromagnetic Interference

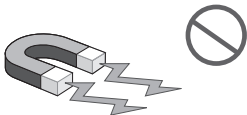

Electronic elements including capacitance and inductance on the device can be affected by external interferences, such as conducted emission by capacitance coupling, inductance coupling, and impedance coupling. To decrease the interferences, make sure to take the following measures:

- Use the power supply that can effectively filter interference from the power grid.
- Keep the device far from high-frequency and strong-current devices such as radio transmitting station.
- Use electromagnetic shielding when necessary.

Lightning Protection



Extremely high voltage currents can be produced instantly when lightning occurs and the air in the electric discharge path can be instantly heated up to 20,000 °C. As this instant current is strong enough to damage electronic devices, more effective lightning protection measures should be taken.

- Ensure that the rack and the device are well earthed.
- Make sure the power socket has a good contact with the ground.
- Keep a reasonable cabling system and avoid induced lightning.
- Use the signal SPD (Surge Protective Device) when wiring outdoor.



Note:

For detailed lightning protection measures, refer to the **Lightning Protection Guide**:
https://www.tp-link.com/us/configuration-guides/lightning_protection_guide/.

Installation Site

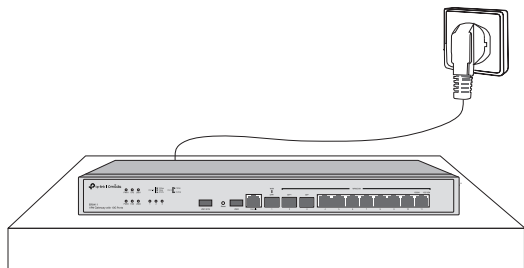

When installing the device on a rack or a flat workbench, attach much importance to the following items:

- The rack or workbench is flat, stable, and sturdy enough to support the weight of 5.5 kg at least.
- The rack or workbench has a good ventilation system. The equipment room is well ventilated.
- The rack is well grounded. Keep the device less than 1.5 meters away from the power socket.

2.3 Installation Tools

- Phillips screwdriver
- ESD-preventive wrist wrap
- Cables



Note:

These tools are not included with our product. If needed, you can purchase them separately.

2.4 Product Installation

▪ Desktop Installation

To install the device on the desktop, follow the steps:

1. Set the device on a flat surface which is strong enough to support the entire weight of the device with all fittings.
2. Remove the adhesive backing papers from the rubber feet.
3. Turnover the device and attach the supplied rubber feet to the recessed areas on the bottom at each corner of the device.

Figure 2-1 Desktop Installation

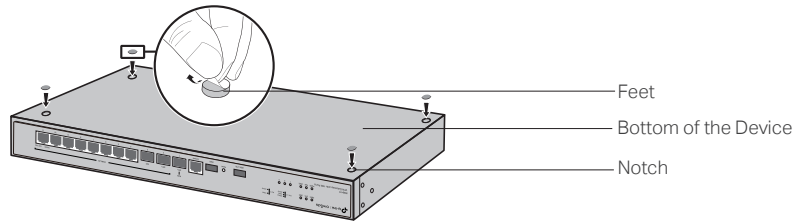

▪ Rack Installation

To install the device in a rack, follow the instructions described below:

1. Check the efficiency of the grounding system and the stability of the rack.
2. Secure the supplied rack-mounting brackets to each side of the device with supplied screws, as illustrated in the following figure.

Figure 2-2 Bracket Installation

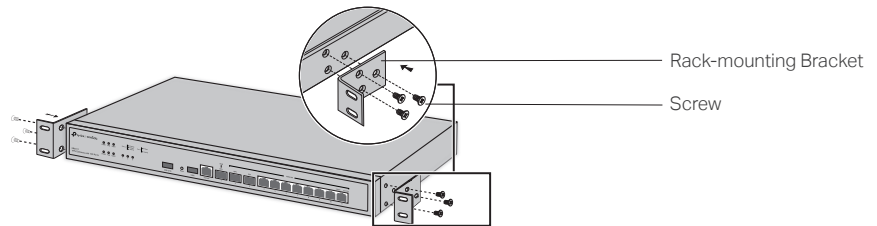

3. After the brackets are attached to the device, use suitable screws (not provided) to secure the brackets to the rack, as illustrated in the following figure.

Figure 2-3 Rack Installation

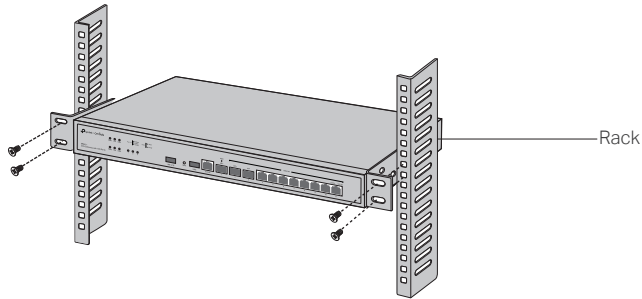

Caution:

- Leave 5 to 10 cm gaps around the devices for air circulation.
- Avoid placing heavy things on the device.
- Place the device with its bottom facing downwards.
- Mount devices in sequence from the bottom to top of the rack and ensure a certain clearance between devices for the purpose of heat dissipation.

Chapter 3 Hardware Connection

Follow the steps below to connect your gateway to the internet.

Connect via Ethernet

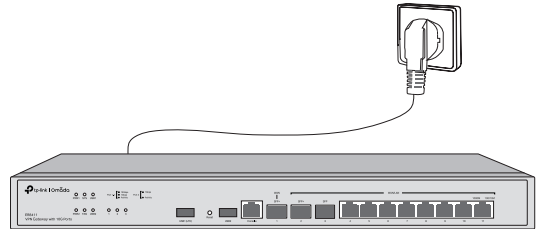
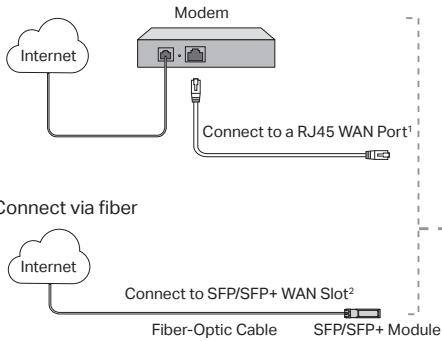

Note:

- 1. If you want to connect to the internet via another RJ45 WAN port, refer to FAQ-Q1 to configure your desired port to a WAN port first, and connect the port to the internet via an RJ45 cable.
- 2. If you want to connect to the internet via another SFP/SFP+ WAN port, refer to FAQ-Q1 to configure the SFP/SFP+ port as a WAN port first, and connect the SFP/SFP+ port to the internet via an SFP/SFP+ module.

Chapter 4 Software Configuration

4.1 For Common Gateways

The common gateway (e.g., ER7412-M2, ER8411, ER7406) supports two configuration options:

- Standalone Mode: Configure and manage the gateway by itself.
- Controller Mode: Configure and manage network devices centrally. It is recommended in large-scale networks, which consist of a large number of devices such as access points, switches, and gateways.

▪ Standalone Mode

In Standalone Mode, use a computer to configure and manage the gateway.

Figure 4-1 Topology for Standalone Mode

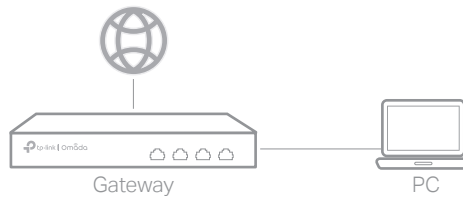

1. Connect a computer to a LAN port of the gateway with an RJ45 cable properly. If your computer is configured with a fixed IP, change it to Obtain an IP address automatically.
2. Open a web browser and type the default management address **192.168.0.1** in the address field of the browser, then press the Enter key.
3. Create a username and a password for subsequent login attempts and for security.
4. Use the username and password set above to log in to the webpage.
5. After a successful login, you can configure the function by clicking the setup menu on the left side of the screen.



Note:

Make sure the ports you select as WAN ports correspond to the real situation.

For the detailed configurations, refer to the User Guide and CLI Guide. The guides can be found on the download center of our official website: <https://www.tp-link.com/support/download/>.

▪ Controller Mode

Controller Mode applies to the large scale network with mass devices. All devices can be centrally configured and monitored via Omada Hardware Controller or Omada Software Controller.

Option 1 Via Omada Hardware Controller

The Omada Hardware Controller (purchased separately) is a good alternative if you have no spare PC to run the Omada Software Controller.

For more details, refer to the Installation Guide of your Omada Hardware Controller.

Figure 4-2 Manage the network via Hardware Controller

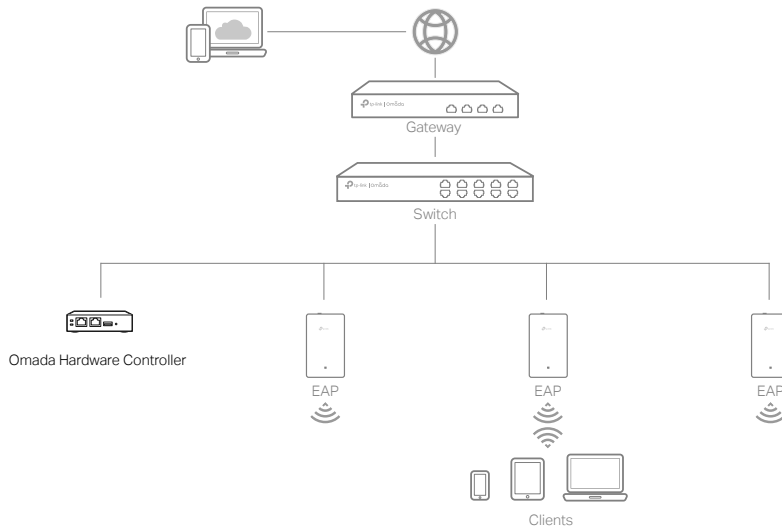

1. As Omada Hardware Controller gets its IP address from the DHCP server of the gateway, we don't know its IP address explicitly. However, we can find it out on the gateway's DHCP client list.
 - a. You need first find the IP address of the gateway. Open the command line on your PC and enter **ipconfig**. In the result list, find the Default Gateway, which is also the IP address of the gateway.
 - b. Launch a web browser and enter the IP address of the gateway. Create a username and password, and log into the gateway's web page. Then go to **Network > LAN > DHCP Client List** to find the IP address of your controller according to its MAC address.
 - c. Enter the IP address of your controller in the address bar to open its web page.
2. On the Omada Controller's web page, follow the wizard to complete the quick setup.
3. After the quick setup, the login page appears. Enter the username and password you have created and click **Log in**. Then you can further configure the controller.
4. (For Remote Management) You can remotely access and manage your controller via Omada Cloud Service.
 - a. Make sure that Cloud Access is enabled on your controller and your controller has been bound with your TP-Link ID.
 - b. Launch a web browser and enter **https://omada.tplinkcloud.com** in the address bar. Enter your TP-Link ID and password to log in. Click **+ Add Controller** and choose **Hardware Controller** to add your controller. Then you can further configure the controller.

Option 2 Via Omada Software Controller

The Omada Software Controller is free software for centralized management. To centrally manage your devices, the Omada Software Controller needs to continually run on your computer.

Figure 4-3 Manage the network via Omada Software Controller

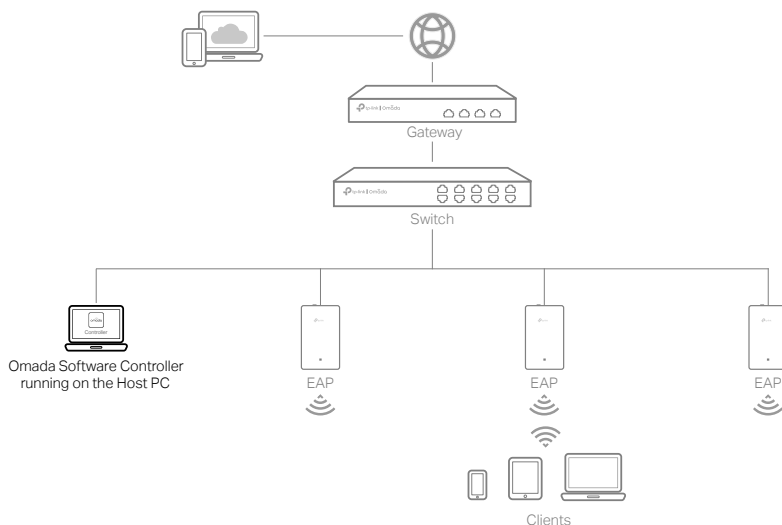

1. On a PC with Windows OS or Linux OS, download the Omada Software Controller installation file from <https://www.tp-link.com/support/download/omada-software-controller/>.



Note:

To download Omada Software Controller successfully, it is recommended to configure the gateway's network to access the internet. Refer to Standalone Mode to launch the management page and go to **Network > WAN** to complete the configuration.

2. Run the file and follow the wizard to install the Omada Software Controller.
3. Launch the Omada Software Controller and follow the step-by-step instructions to complete the quick setup.
4. After the quick setup, the login page appears. Enter the username and password you created and click **Log in**. Then you can further configure the network.

▪ **More Management Methods**

* **Via Omada Cloud Portal**

After installing Omada Software Controller, you can remotely access the controller through Omada Cloud Portal. Follow the steps below.

- a. Enable **Cloud Access** on the setting page on the controller and bind a TP-Link ID to your controller. If you have configured this in the setup wizard, skip the step.
- b. Launch a web browser and enter <https://omada.tp-linkcloud.com> in the address bar.
- c. Enter your TP-Link ID and password to log in. A list of controllers that have been bound with your TP-Link ID will appear. Then you can click Launch to further configure the controller.

For the detailed configurations, refer to the User Guide of the controller. The guide can be found on the download center of our official website: <https://www.tp-link.com/support/download/>.

* Via Omada App

With the Omada app, you can also manage your controller at a local site or a remote site via your mobile device.



4.2 For Gateways with Controller Ability

ER8411C-M2 is illustrated as an example in this section.

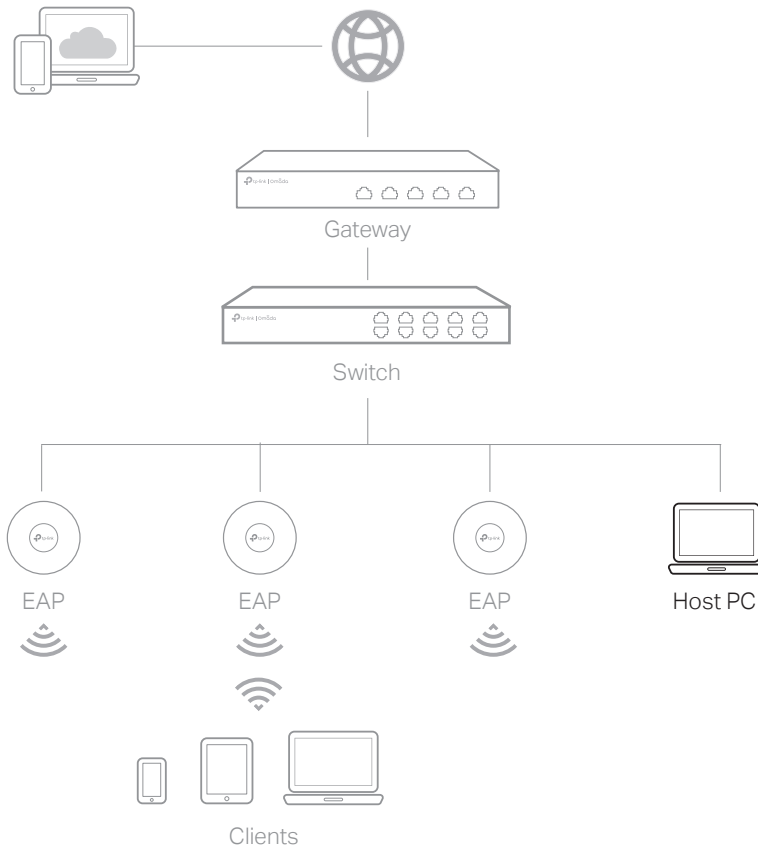

1. Connect a computer to a LAN port of the gateway with an RJ45 cable properly. If your computer is configured with a fixed IP, change it to Obtain an IP address automatically.
2. Open a web browser and type the default management address **192.168.0.1** in the address field of the browser, then press the Enter key.

3. Get started with the **Omada Setup Wizard** to set up the network.
4. After the network setup is complete, click **Finish** to configure more settings and manage your network.

For detailed configurations, refer to the User Guide of the gateway. The guide can be found on the download center of our official website: <https://www.tp-link.com/support/download/>.

More management methods

* Via Omada App

With the Omada app, you can also manage your gateway at a local site or a remote site via your mobile device.



* Via Omada Cloud Portal

You can also remotely access the gateway through Omada Cloud Portal. Follow the steps below.

- a. Enable **Cloud Access** on the setting page on the controller and bind a TP-Link ID to your controller. If you have configured this in the setup wizard, skip the step.
- b. Launch a web browser and enter <https://omada.tplinkcloud.com> in the address bar.
- c. Enter your TP-Link ID and password to log in. A list of controllers that have been bound with your TP-Link ID will appear. Then you can click Launch to further configure the controller.

For the detailed configurations, refer to the User Guide of the controller. The guide can be found on the download center of our official website: <https://www.tp-link.com/support/download/>.

Appendix A Troubleshooting

Q1. What should I do if I want to change the mode of the WAN/LAN ports?

1. Recommended) Refer to the Interface Description table of this guide for the default mode of the WAN/LAN ports.
2. Connect a computer to a LAN port of this gateway. If your computer is configured with a fixed IP address, change it to Obtain an IP address automatically.
3. Log in to this gateway's management page at 192.168.0.1. Go to Network > WAN > WAN Mode, change the mode of the WAN/LAN ports by ticking the checkboxes, and click Save.

Q2. What should I do if I need to connect this gateway to a modem gateway?

Check the LAN IP address of the modem gateway first. If the LAN IP address of the modem gateway is 192.168.0.1, which is the same as the default LAN IP address of this gateway, follow the steps to change the LAN IP address of this gateway:

1. Connect a computer to a LAN port of this gateway. If your computer is configured with a fixed IP address, change it to Obtain an IP address automatically.
2. Log in to this gateway's management page at 192.168.0.1, and go to Network > LAN > LAN. In the Network List section, change the IP address 192.168.0.1 to 192.168.1.1, and click OK.

Appendix B Specifications

Specifications for gateways with RJ45 Ports and SFP/SFP+ Slots

Item	Content
Standards	IEEE 802.3, IEEE 802.3u, IEEE 802.3ab, IEEE 802.3ad, IEEE 802.3z, IEEE 802.3x, IEEE 802.1p, IEEE 802.1q, IEEE 802.1x, IEEE 802.1d, IEEE 802.1s, IEEE 802.1w, IEEE 802.1ab
Transmission Medium	10BASE-T: 2-pair UTP/STP of Cat. 3,4,5 (maximum 100 m) 100BASE-TX: 2-pair UTP/STP of Cat. 5 or above (maximum 100 m) 1000BASE-T: 4-pair UTP/STP of Cat. 5e or above (maximum 100 m) 2.5GBASE-T: 4-pair UTP/STP of Cat. 5e or above (maximum 100 m) (for ER7412-M2 & ER8411C-M2) 100BASE-FX/LX10/BX10: MMF, SMF 1000BASE-SX/LX/LX10/BX10: MMF, SMF 10GBASE-SR/LR: MMF, SMF (For ER8411 & ER8411C-M2) 10GSFP+CU SFP+ Direct Attach Cable (SM5220-1M, SM5220-3M) (For ER8411 & ER8411C-M2)
LED	ER7412-M2: PWR, SYS, USB, Link/Act, 11, 12 ER7406: PWR, SYS, SFP, USB, Link/Act ER8411: PWR1, PWR2, SYS, FAN, USB1, USB2, 1, 2, 3, Link/Act ER8411C-M2: PWR, SYS, USB, CLOUD, 1, 2, Link/Act



EU Declaration of Conformity

For ER7406:

TP-Link hereby declares that the device is in compliance with the essential requirements and other relevant provisions of directives 2014/30/EU, 2014/35/EU, 2009/125/EC, 2011/65/EU and (EU)2015/863.

The original EU Declaration of Conformity may be found at <https://www.tp-link.com/en/support/ce/>

For other models:

TP-Link hereby declares that the device is in compliance with the essential requirements and other relevant provisions of directives 2014/30/EU, 2014/35/EU, 2011/65/EU and (EU)2015/863.

The original EU Declaration of Conformity may be found at <https://www.tp-link.com/en/support/ce/>



UK Declaration of Conformity

TP-Link hereby declares that the device is in compliance with the essential requirements and other relevant provisions of the Electromagnetic Compatibility Regulations 2016 and Electrical Equipment (Safety) Regulations 2016.

The original UK Declaration of Conformity may be found at <https://www.tp-link.com/support/ukca/>



Продукт сертифіковано згідно з правилами системи УкрСЕПРО на відповідність вимогам нормативних документів та вимогам, що передбачені чинними законодавчими актами України.

Safety Information

- Keep the device away from water, fire, humidity or hot environments.
- Do not attempt to disassemble, repair, or modify the device. If you need service, please contact us.
- Place the device with its bottom surface downward.
- The plug on the power supply cord is used as the disconnect device, the socket-outlet shall be easily accessible.
- Plug the product into the wall outlets with earthing connection through the power supply cord or plug.
- The socket-outlet shall be installed near the equipment and shall be easily accessible.

This equipment is not suitable for use in locations where children are likely to be present, such as family environment, school, children's playground and so on.

Please read and follow the above safety information when operating the device. We cannot guarantee that no accidents or damage will occur due to improper use of the device. Please use this product with care and operate at your own risk.



To ask questions, find answers, and communicate with TP-Link users or engineers, please visit <https://community.tp-link.com/business> to join TP-Link Community.



For technical support, the user guide and other information, please visit <https://www.tp-link.com/support/?type=smb>, or simply scan the QR code.

